

General Purpose Rectifier

Typical Applications

For use in general purpose rectification of power supplies, inverters, converters, and freewheeling diodes for consumer, and telecommunication.

Features

- High efficiency
- High current capability
- High reliability
- High surge current capability
- Low power loss
- Glass passivated chip junction
- Solder dip 265 °C max.10 s, per JESD 22-B106

Mechanical Data

- Package:TO-247-2L
- Molding compound meets UL 94 V-0 flammability rating, RoHS-compliant
- Terminals: Tin plated leads, solderable per J-STD-002 and JESD22-B102
- Polarity:Color band denotes cathode end

TO-247-2L

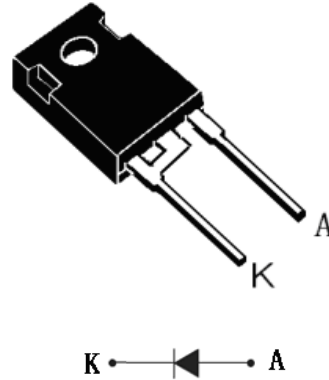

Maximum Ratings (Ta=25 °C Unless otherwise specified)

PARAMETER	Symbol	Unit	MGR6016PT
Maximum Repetitive Peak Reverse Voltage	V _{RRM}	V	1600
Maximum RMS Voltage	V _{RMS}	V	1120
Maximum DC blocking Voltage	V _{DC}	V	1600
Average Forward Current @Half-sine wave, Resistance load With heatsink T _c =90°C	I _o	A	60
Average Forward Current @Half-sine wave, Resistance load Without heatsink T _c =25°C			15
Forward Surge Current (Non-repetitive) @50HZ sine wave, 1 cycle, Ta=25°C	I _{FSM}	A	800
Current squared time @1ms≤t10≤ms Ta=25°C, Rating of per diode	I ² t	A ² s	3200
Thermal Resistance(Typical) @Between junction and case	R _{θj-c}	°C/W	0.35
Storage Temperature	T _{stg}	°C	-55 ~ +150
Junction Temperature	T _j	°C	-55 ~ +150

Electrical Characteristics (Ta=25°C Unless otherwise specified)

PARAMETER	Symbol	Unit	Conditions	MGR6016PT
Peak Forward Voltage	V _{FM}	V	I _F =60.0A	1.2
Peak Reverse Current	I _{RRM}	μA	VR =V _{DC} @Ta=25°C	5
			VR =V _{DC} @Ta=125°C	500

RATING AND CHARACTERISTICS CURVES (MGR6016PT)

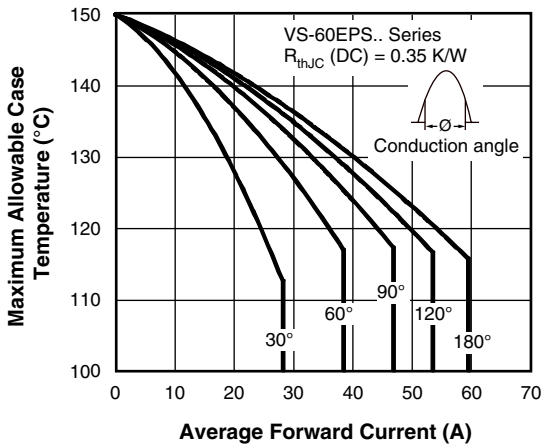

Fig. 1 - Current Rating Characteristics

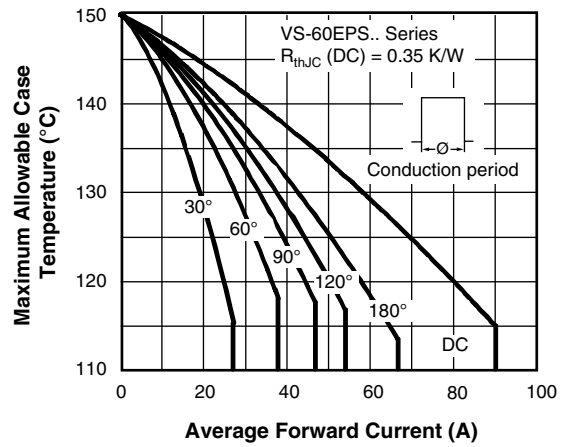

Fig. 2 - Current Rating Characteristics

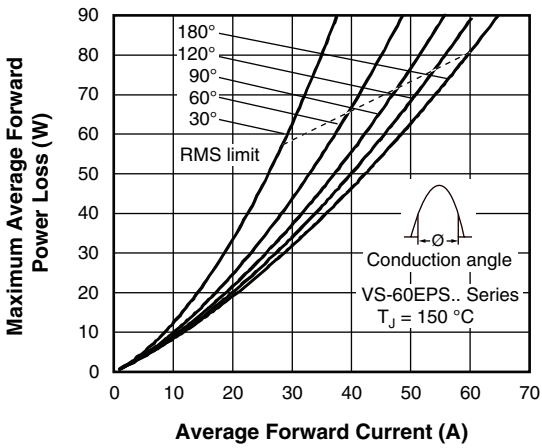

Fig. 3 - Forward Power Loss Characteristics

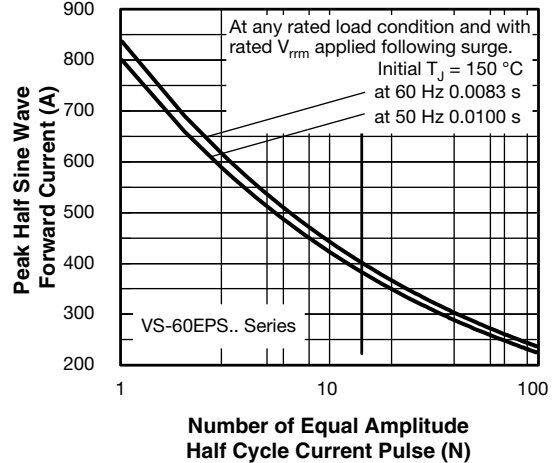

Fig. 5 - Maximum Non-Repetitive Surge Current

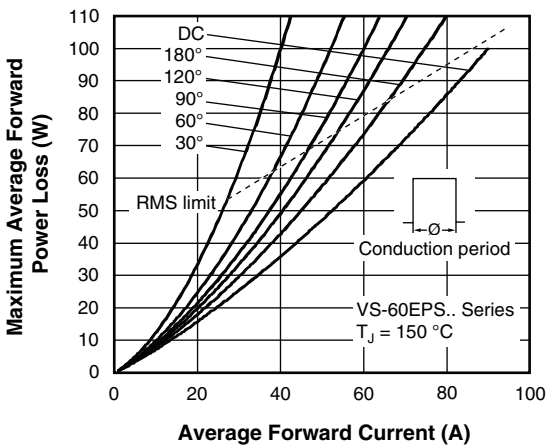

Fig. 4 - Forward Power Loss Characteristics

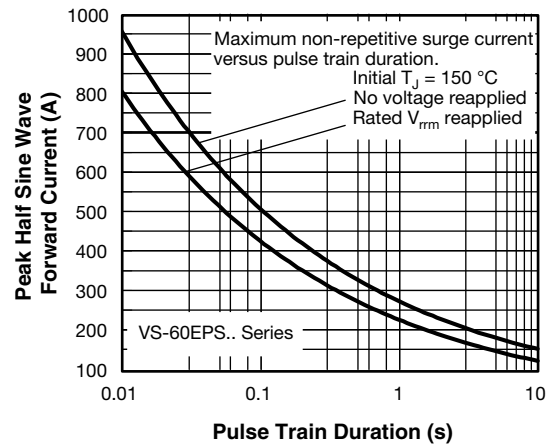

Fig. 6 - Maximum Non-Repetitive Surge Current

RATING AND CHARACTERISTICS CURVES (MGR6016PT)

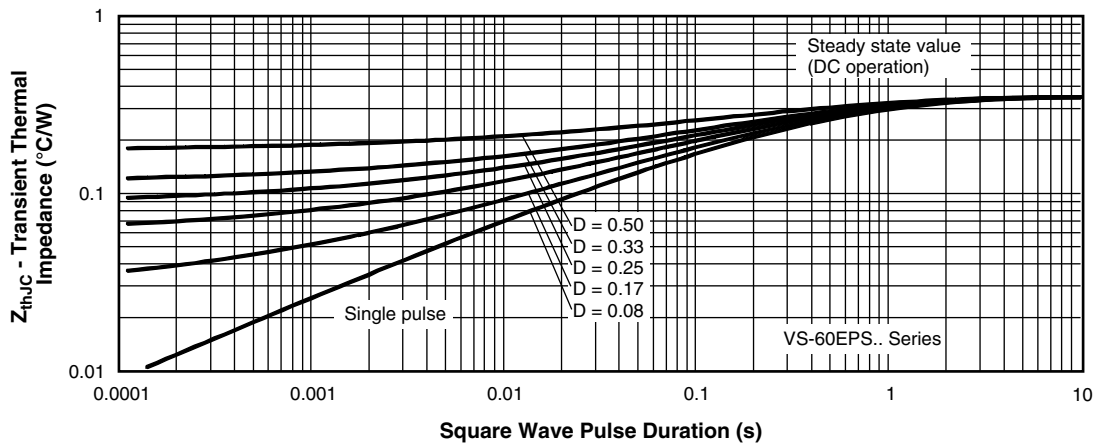
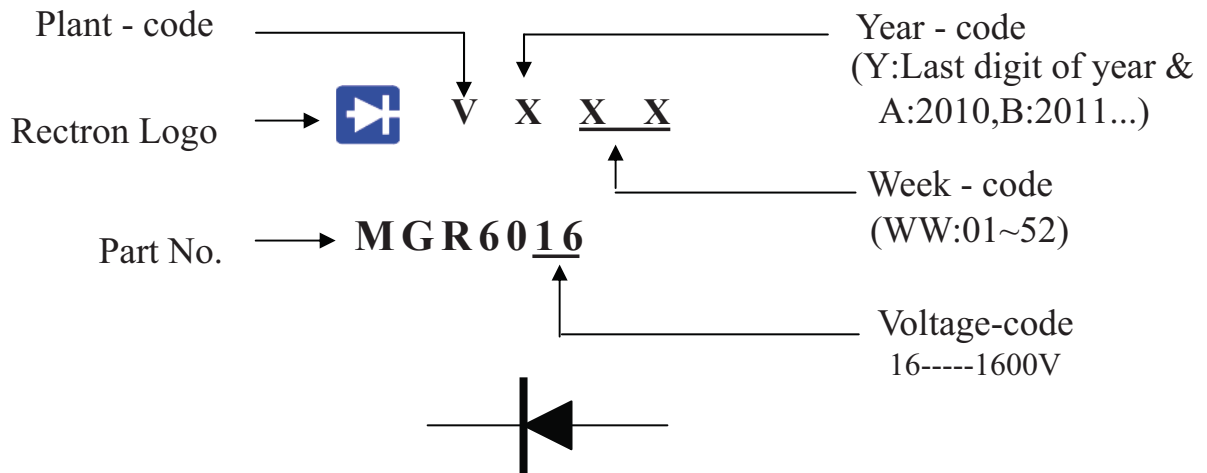

Fig. 8 - Thermal Impedance Z_{thJC} Characteristics

Marking Description



OutlineDimensions

PACKAGE OUTLINE DIMENSIONS

T□-247-2L

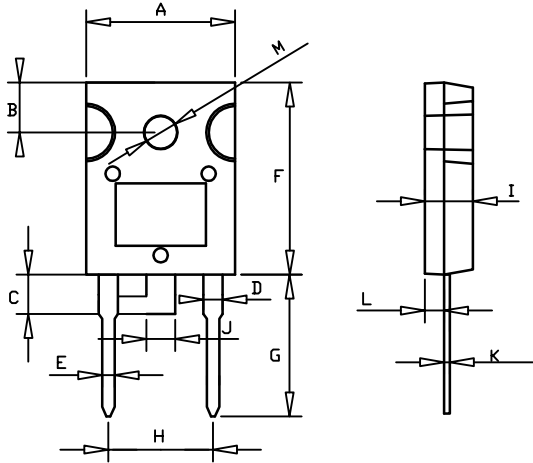

DIM.	Unit(mm)		Unit(inch)	
	Min	Max	Min	Max
A	15.35	15.65	0.604	0.616
B	4.9	5.4	0.192	0.212
C	3.8	4.5	0.149	0.177
D	1.9	2.1	0.074	0.082
E	1.15	1.45	0.045	0.057
F	19.85	20.15	0.781	0.793
G	14.32	14.80	0.563	0.582
H	10.81	11.09	0.420	0.436
I	4.85	5.15	0.190	0.202
J	2.85	3.15	0.112	0.124
K	0.53	0.68	0.020	0.026
L	1.8	2.21	0.070	0.087
M	3.15	3.8	0.124	0.149

PACKAGING OF DIODE AND BRIDGE RECTIFIERS

TUBE PACK

PACKAGE	PACKING CODE	EA PER BOX	INNER BOX SIZE (mm)	CARTON SIZE (mm)	EA PER CARTON	WEIGHT(Kg)
TO-247-2L	-C	600	560*155*55	570*284*185	3,000	-----

DISCLAIMER NOTICE

Rectron Inc reserves the right to make changes without notice to any product specification herein, to make corrections, modifications, enhancements or other changes. Rectron Inc or anyone on its behalf assumes no responsibility or liability for any errors or inaccuracies. Data sheet specifications and its information contained are intended to provide a product description only. "Typical" parameters which may be included on RECTRON data sheets and/ or specifications can and do vary in different applications and actual performance may vary over time. Rectron Inc does not assume any liability arising out of the application or use of any product or circuit.

Rectron products are not designed, intended or authorized for use in medical, life-saving implant or other applications intended for life-sustaining or other related applications where a failure or malfunction of component or circuitry may directly or indirectly cause injury or threaten a life without expressed written approval of Rectron Inc. Customers using or selling Rectron components for use in such applications do so at their own risk and shall agree to fully indemnify Rectron Inc and its subsidiaries harmless against all claims, damages and expenditures.